

DURABLE & SUPERIOR COVERS

FOR CARTS, SHELVING, EQUIPMENT & MORE!

HEALTH CARE • LAUNDRY • HOSPITALITY • INDUSTRIAL • CUSTOM



**AFFORDABLE
& EASY TO
ORDER!**

- Drape Covers for Carts or Shelving
- Bulk Carts and Baskets
- Round-Trippers
- Front Covers or Panels
- Supply Carts
- Pool Towel Carts
- Luggage Carts
- Outdoor Solutions
- Custom Designs to Meet Your Requirements 100%



Tecni *Carts & Shelving & Covers*
Quip
SINCE 1961



WWW.TQIND.COM
TQCARTS@TQIND.COM
TOLL FREE: 800-826-1245

CART COVERS & MORE

DURABLE STANDARD & CUSTOM COVERS
MADE AT THE TQ FACTORY LOCATED IN TEXAS



FIRE
RETARDANT

*The TQ Promise
Our Covers fit "Your"
Carts like a Glove!*

STANDARD FEATURES

3 Material Types to Choose from

- Poly Denier 400 count
- 10oz. Vinyl
- 16 oz. Vinyl

Variety of Colors - to complement any décor!
(See page 5 for color and option samples)

FEATURES

- Zipper or Velcro Closures
- Velcro Ties - located inside corner seams, every 15 inches. Fastens cover to cart's frames - keeps cover intact and looking beautiful!
- Measurement Guides located at end of brochure.



Velcro Ties: Standard Features Secures cover to cart edges

FULL DRAPE COVERS: to fit on any size, make or model of cart or shelving.



Drape Covers
Variety of Colors



Round Style Drape Cover, fits beautifully

Square Style Drape Cover with Transparent Front Flap, allows viewing of inventory.



Square Style Shelving Cover:
Ideal for all types of shelving



2 Way Entrance Covers
(Transparent or Vinyl)



SMALL CART COVERS:

Created to fit any size of small cart. Choose from a variety of materials types and colors. Handle cut-outs available.



Bulk Cart (A)



Round Tripper Cart (B)

LAUNDRY TRANSPORT:

BULK CART (A) OR ROUND TRIPPER (B)

Your choice of either Full Drape Style or Cut-out Cap Style. Both will cover cart and protect linens or supplies.



Ask about TQ Basket Carts

BASKET TYPE CART COVERS:

Designed to fit any size or brand of basket type cart. Standard with bungee cord at top. Upgrade with 12" overhang on edges, allows cover to rise and fall with load and still fit and cover the cart's body.

POOL & BEACH CARTS



LUGGAGE CART COVERS

Any style or size

Measurement Forms are located on pages 7-12 to assist you, or call the TQ COVER CREW for assistance.

AFTER *10 Years* OF RESEARCH & MANUFACTURING TQ "PERFECTED"

PASS-THRU COVER SYSTEM

TQ's
Exclusive
Replaceable
Strips
SAVES \$\$

PT-Covers - designed with **ECONOMICAL Replaceable Strips** that any member of your linen services team can change out when worn or torn. **SAVE \$\$\$ Eliminates buying a new cover.**

- **Drape Cover Styles** for any Brand or Size of Cart.
- **Available on New Tecni-Quip Carts** - any Model.
- **Retro Fit Front Covers** on Existing Tecni-Quip Carts, any Cart or Shelving Size and Brand.

Unique Replaceable Pass-Thru Strips

6" Acrylic Strips
Just the Right Weight .040
Strips Overlap Slightly

EFFICIENT!

Linen Slips Easily out of Cart and
Contents Remain Protected



EZ to Replace Strips Individually Secure with Custom Fasteners *Tough & Durable. Hospital Tested for Perfection*

• Panels Will **NOT** stick Together!



Zipper or Velcro Closures

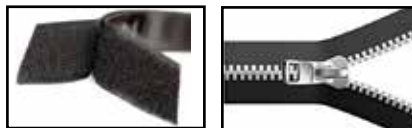

Left: Pass-Thru on Drape Cover

Right: All Drape Style Pass-Thru Covers are also equipped with a solid front vinyl cover to seal load in transport.



Optional Double Cover System

Combines Pass-Thru with Solid Front Vinyl Cover to Seal Load during transport. See page 4 for details.

Cover Color Choices

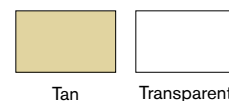
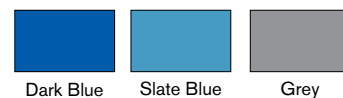

Additional Colors on Page 5

Contact a COVER CREW Member to Quickly Answer your Questions, Help with Sizing or Customization.



FIRE
RETARDANT

Tecni-Quip
A DIVISION OF TQI *Carts*



Manufacturing & Sales: Seguin, Texas USA • TOLL FREE: **800-826-1245**
Email: TQcarts@TQind.com • View All TQ Models at www.TQind.com



FRONT COVERS

ANY BRAND & ANY SIZE OF
CART OR SHELVING

*TQ Customers - Call Us First!
We keep your records & can
provide part # and price.*

Measuring your Cart for a Replacement Front Cover

HOW TO MEASURE

- 1. TECNI-QUIP Carts:** Required will be an outside measurement of the length and the overall height, from the floor to the top of the cart.
 - See measurement guide page 8 or Send us a photo of your cart via email or fax and our Cover Crew will assist you!
- 2. OTHER CART or SHELVING BRANDS:** Please see front cover measurement guide on page 8, fill out the form and send to us via fax or e-mail.

You may convert Zipper Covers to Velcro or Vice Versa **- OR -**
You may Convert any Cover to the "NEW" Pass-Thru Front Cover System



TRANSPARENT PASS-THRU FRONT COVER

Permits Easy Access to Linens and Meets Joint Commission Codes.

- Overlapping transparent strips are formed into a front panel style cover
- Permits cart's front cover to remain down at all times
- Inventory can be easily viewed, maintained and removed



Vinyl Front Panel Covers
for Tecni-Quip or any other
brand of cart

DOUBLE COVER SYSTEM

Great for any transport situation in house or over the road.

- Solid Vinyl Panel with Zipper Closures is placed in front of the Pass-Thru Cover System Front.
- 2 cover system secures the linen load "inside the cart" during transport.
- When cart is in operation, the outer vinyl panel is positioned on top of cart, revealing the clear pass through front cover.



Zipper or Velcro Closures

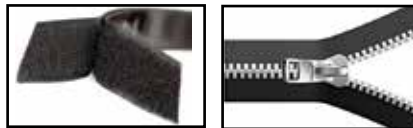

Transparent Front Panel

for any make or model of cart or shelving



Cover Color Choices

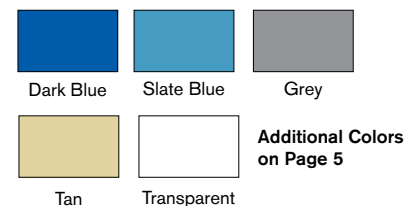

**Contact a COVER CREW Member to Quickly Answer your Questions,
Help with Sizing or Customization.**



FIRE
RETARDANT

Tecni-Quip
A DIVISION OF TQI *Carts*



Manufacturing & Sales: Seguin, Texas USA • TOLL FREE: **800-826-1245**
Email: TQcarts@TQind.com • View All TQ Models at www.TQind.com



CART COVERS

STANDARD FEATURES & OPTIONS



FABRIC SELECTION

- Poly Denier: 400 count
- 10 oz. Vinyl
- 16 oz. Vinyl

STANDARD COVER COLORS

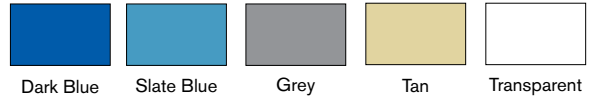

CLOSURE CHOICE

Zipper or Velcro

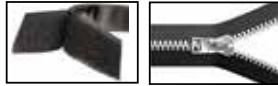

SPECIALTY COVER COLORS

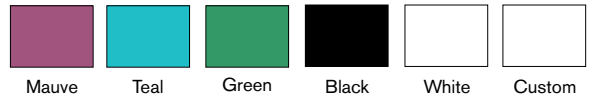

Transparent Front Panel



Transparent Pass-Thru Cover



Webbing for Over-the-Road Transport



Velcro Ties Standard on Drape Covers: Strategically placed on vertical inside edges to hold cover to frame



Handle Cut Out



Premium Barrier Handle Cut-Out Systems (Upgrade)

OPTIONS

- **Transparent: Front Panel**
- **Pass-Thru Acrylic Static Free Strips, Overlapped**
- **Double Front Cover System:** Combines Pass-Thru Front Cover with 16 oz. Vinyl Cover to seal cart during transport
- **Replacement Strips for All Pass-Thru Covers:** *Unique Feature of Tecni-Quip Transport Cover System - Call for pricing and instruction.*
- **Transport Webbing** – placed on front panel for box truck, tractor trailer or towing transportation of cart
- **Velcro Ties (standard)** – located inside corner seams, fastens cover to cart's frames – *keeps drape cover intact & looking beautiful!*
- **Handle Cut Outs** per your specifications, please make comments here and on the provided measurement guide. _____
- **PREMIUM Barrier Handle Cut Out** – please make comments here or on the provided measurement guide. _____
- **Stenciling:** (Your wording or design request) _____
- **Custom Features You Would Like:** Describe here custom features, colors or other items. _____



ORGANIZERS

- **Transparent Routing or Inventory Pocket:** Standard Size 9" x 12" or custom ____" x ____"
- **Reject Linen External Bag:** Standard Size 10" x 12" or Custom ____" x ____"
- **Paperwork or Supply Organizers:** Variety of options see photos below or custom - *contact us for custom ideas.*



Transparent Inventory or Routing Pocket



Reject Linen Bag



External Pocket for Paperwork or Form Organizer



5 Pocket Supply Organizer



10 Pocket Supply Organizer

Contact a COVER CREW Member to Quickly Answer your Questions, Help with Sizing or Customization.



FIRE RETARDANT

Tecni-Quip
A DIVISION OF TQI



Manufacturing & Sales: Seguin, Texas USA • TOLL FREE: **800-826-1245**
Email: TQcarts@TQind.com • View All TQ Models at www.TQind.com

MEASUREMENT GUIDE FOR DRAPE COVERS & SMALL DRAPE COVERS BY TECNI-QUIP
 SEND A PHOTO OF YOUR ITEM(S) TO COVER AND OUR COVER CREW WILL MAKE THE BEST POSSIBLE COVER FOR YOUR PROPERTY.

SQUARE CORNERS

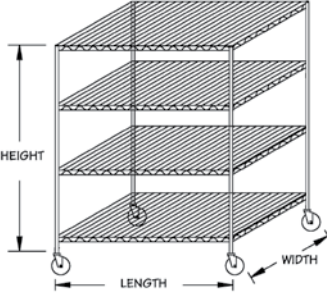

DRAPE COVERS

Quantity: _____

Measurements: _____ W _____ L _____ H
(Height is from the BASE to top of the cart)

ROUNDED CORNERS

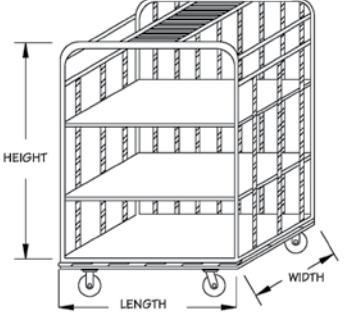

Corners: Square Rounded

Material Type: 16oz. Vinyl (Heavy Duty) 10oz. Vinyl Poly Denier

Closure: Zipper Velcro

Color 16oz. Vinyl:

Teal Slate Blue Gray Dark Blue Tan

Other Color preferred _____

Color 10oz. Vinyl:

Slate Blue Mauve Dark Blue Tan Green

Other Color preferred _____

Color Poly Denier:

Burgundy Tan Dark Blue Charcoal Grey

Other Color preferred _____

Please see **Options & Upgrade Page**

Transparent Front Only

Transparent Pass-Thru Front Combined w/Vinyl Front Cover

Handle Cut-Outs (Describe locations please)

Stenciling Your Wording: _____

Transparent routing or inventory pockets (9"x12" Standard) or your size requirement _____" x _____"

External pocket for soiled, reject linen or inventory forms

Transport Webbing

Comments/Special Request: _____

SMALL CART COVERS



Quantity: _____ Measurements: _____ W _____ L _____ H
(Height is from the top of BASE to top of the cart)

Material Type: 10oz. Vinyl Poly Denier **Closure:** Zipper Velcro

Color 10oz. Vinyl:

Slate Blue Mauve Dark Blue Tan Green Other Color preferred _____

Color Poly Denier:

Burgundy Tan Dark Blue Charcoal Grey Other Color preferred _____

Please see **Options & Upgrade Page**

Transparent Front Panel Stenciling: Wording _____

Transparent Pass-Thru Front Double Cover System

Transparent routing or inventory pockets (9"x12" Standard) or your size requirement _____" x _____"

Handle Cut-Outs: _____
Describe Location

Comments/Special Request: _____

Name _____ Title _____

Company/Facility _____

Address _____ City _____ State _____ Zip Code _____

Phone Number _____ Fax Number _____ E-mail _____

MEASUREMENT GUIDE FOR FRONT TYPE & BASKET COVERS BY TECNI-QUIP

SEND A PHOTO OF YOUR ITEM(S) TO COVER AND OUR COVER CREW WILL MAKE THE BEST POSSIBLE COVER FOR YOUR PROPERTY.

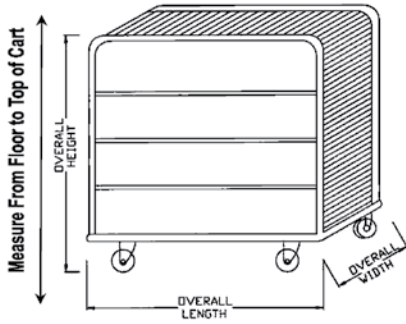

FRONT COVERS

If you are measuring a **TECNI-QUIP** cart, please record the outside width, length and height.

When measuring **OTHER BRANDS** of carts please record the length and the height where the cover is to fit.

Quantity: _____

Measurements: _____ W _____ L _____ H (Height: See above explanation.)

Please see **Options & Upgrade Page**

Corners: Square Rounded

Material Type: 16oz. Vinyl (Heavy Duty) 10oz. Vinyl Transparent Front ONLY

Closure: Zipper Velcro

Color 16oz. Vinyl:
 Teal Slate Blue Gray Dark Blue Tan
 Other Color preferred _____

Color 10oz. Vinyl:
 Slate Blue Mauve Dark Blue Tan Green
 Other Color preferred _____

Color Poly Denier:
 Burgundy Tan Dark Blue Charcoal Grey
 Other Color preferred _____

Pass-Thru Transparent Front ONLY

Double Cover System: Pass-Thru Combined with Vinyl Front Cover in Choice of Color

Handle Cut-Outs (Describe locations please)

Stenciling Your Wording: _____

Transparent routing or inventory pockets (9"x12" Standard) or your size requirement _____" x _____"

External pocket for soiled, reject linen or inventory forms

Transport Webbing

Comments/Special Request: _____

BASKET COVERS

Basket Covers Standard with: Choice of 10 oz Vinyl or Poly Denier. Cover will be constructed with 12" drop from the cart's lip with bungee to secure to the cart and tighten slightly.

Optional: Longer Drop Length at No additional cost. When choosing this option, indicate if you need bungee with the longer length.



Quantity: _____

Measurements:

_____ W _____ L _____ Drop Length Optional

Color 10oz. Vinyl:

Slate Blue Mauve Dark Blue Tan Green

Other Color preferred _____

Color Poly Denier:

Burgundy Tan Dark Blue Charcoal Grey

Other Color preferred _____

Stenciling Your Wording: _____

Comments/Special Request: _____

Name _____ Title _____

Company/Facility _____

Address _____ City _____ State _____ Zip Code _____

Phone Number _____ Fax Number _____ E-mail _____



PLEASE FAX OR EMAIL THIS FORM • FAX: 830-401-0600

EMAIL: TQcarts@TQind.com

MANUFACTURING AND SALES: SEGUIN, TEXAS • LOCAL & INTL 830-401-4400
 WWW.TQHOTELS.COM • TOLL FREE 800-826-1245

FORM: BTC-15



MEASUREMENT GUIDE FOR BULK & TURN-ABOUT "ROUNDTRIPPER" CART COVERS

SEND A PHOTO OF YOUR ITEM(S) TO COVER AND OUR COVER CREW WILL MAKE THE BEST POSSIBLE COVER FOR YOUR PROPERTY.

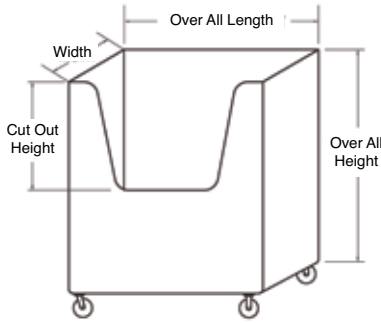

BULK COVERS

Quantity: _____

Measurements: _____ W _____ L _____ H (Height of cover should exceed Cut-Out by 2"-3")

Material Type: 16oz. Vinyl (Heavy Duty) 10oz. Vinyl Poly Denier

Please see **Options & Upgrade Page**

Handle Cut-Outs (Describe locations please)

Color 10oz. Vinyl:
 Slate Blue Mauve Dark Blue Tan Green
 Other Color preferred _____

Stenciling Your Wording:

Color Poly Denier:
 Burgundy Tan Dark Blue Charcoal Grey
 Other Color preferred _____

Transparent routing or inventory pockets (9"x12" Standard) or your size requirement _____" x _____"

External pocket for soiled, reject linen or inventory forms

Comments/Special Request: _____

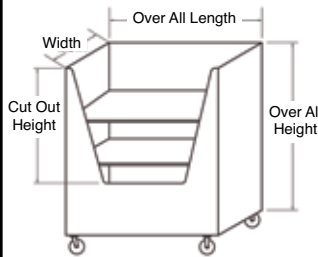

TURN-ABOUT - ROUNDTRIPPER

Quantity: _____

Measurements: _____ W _____ L _____ H (Height of cover should exceed Cut-Out by 2"-3")

Material Type: 16oz. Vinyl (Heavy Duty) 10oz. Vinyl Poly Denier

Please see **Options & Upgrade Page**

Handle Cut-Outs (Describe locations please)

Color 10oz. Vinyl:
 Slate Blue Mauve Dark Blue Tan Green
 Other Color preferred _____

Stenciling Your Wording:

Color Poly Denier:
 Burgundy Tan Dark Blue Charcoal Grey
 Other Color preferred _____

Transparent routing or inventory pockets (9"x12" Standard) or your size requirement _____" x _____"

External pocket for soiled, reject linen or inventory forms

Comments/Special Requests: _____

Name _____ Title _____

Company/Facility _____

Address _____ City _____ State _____ Zip Code _____

Phone Number _____ Fax Number _____ E-mail _____



PLEASE FAX OR EMAIL THIS FORM • FAX: 830-401-0600

EMAIL: TQcarts@TQind.com

MANUFACTURING AND SALES: SEGUIN, TEXAS • LOCAL & INTL 830-401-4400
 WWW.TQHOTELS.COM • TOLL FREE 800-826-1245

FORM: BTC-15



MEASUREMENT GUIDE FOR YOUR ITEM COVERS

SEND A PHOTO OF YOUR ITEM(S) TO COVER AND OUR COVER CREW WILL MAKE THE BEST POSSIBLE COVER FOR YOUR PROPERTY.

<p style="text-align: center;">Please Draw the shape and dimensions of your item here.</p> <div style="border: 1px solid black; height: 300px; margin: 10px 0;"></div> <p>Material Type: <input type="checkbox"/> 16oz Vinyl <input type="checkbox"/> 10oz Vinyl <input type="checkbox"/> Poly Denier <small>(Heavy Duty)</small></p> <p>Color 10oz Vinyl: <input type="checkbox"/> Slate Blue <input type="checkbox"/> Mauve <input type="checkbox"/> Dark Blue <input type="checkbox"/> Tan <input type="checkbox"/> Green <input type="checkbox"/> Other Color Preferred</p> <p>Color Poly Denier: <input type="checkbox"/> Burgundy <input type="checkbox"/> Tan <input type="checkbox"/> Dark Blue <input type="checkbox"/> Charcoal Grey <input type="checkbox"/> Other Color Preferred</p>	<div style="background-color: black; color: white; text-align: center; padding: 5px; font-weight: bold; font-size: 1.2em;">ITEM COVERS</div> <p>Quantity _____</p> <p>Measurements _____ W _____ L _____ H</p> <p>Description _____ _____ _____ _____ _____</p> <p>Please see Options & Upgrade Page</p> <p><input type="checkbox"/> Handle Cut-Outs (Describe locations please) _____</p> <p><input type="checkbox"/> Stenciling <input type="checkbox"/> Embroider Your Wording: _____</p> <p><input type="checkbox"/> Transparent routing or inventory pockets (9" x 12" Standard) or your size requirements _____ " x _____ "</p> <p><input type="checkbox"/> External pocket for soiled, reject linen or inventory forms</p> <p><input type="checkbox"/> Comments/Special Request: _____ _____</p>
---	---

Name	Title		
Company / Facility			
Address	City	State	Zip Code
Phone Number	Fax Number	E-Mail	

PLEASE FAX OR EMAIL THIS FORM • FAX: 830-401-0600 • EMAIL: TQcarts@TQind.com

MANUFACTURING AND SALES: SEGUIN, TEXAS • LOCAL & INTL 830-401-4400

WWW.TQHOTELS.COM • TOLL FREE 800-826-1245

